



ATTiny84/85 AVR adapter kit building and usage instructions

Version	date	Author	Comments
1.0	25/06/2013	Boris du Reau	Initial version
1.1	30/09/2013	Boris du Reau	Updated document

1	Goal	2
2	Kit content	2
2.1	Tools required	2
2.2	Soldering the components	3
3	What is an AVR programmer?	4
4	Adapter board	5
5	Building your adapter	5
6	Use your AVR adapter	6
6.1	The jumpers	6
6.2	Programming a chip	7
6.2.1	Burning a bootloader	7
6.2.2	Uploading a program	8



1 Goal

The aim of this document is to be a quick assembly guide for the ATTiny 84/85 AVR adapter kit. The kit is using classic components on purpose so that anybody can do it without any major difficulties.

2 Kit content

An epoxy board with all the components drawn and the components in a plastic bag

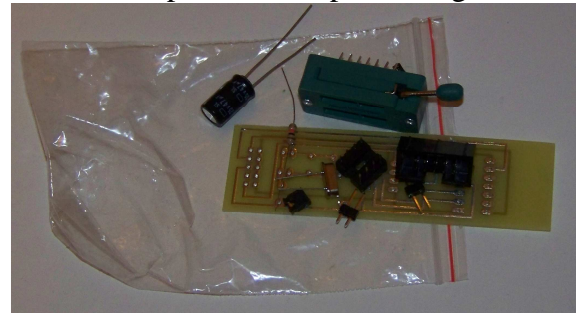
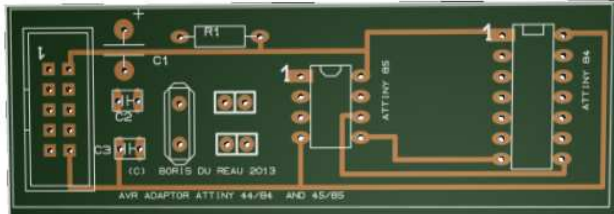



This is a double side board make sure that you solder the components on the right side.

2.1 Tools required

Holes in the board have already been drilled to the correct diameter depending on the component used, you just need to plug them and solder them.

The tools below are the minimum needed to build the kit.

Solder	
Wire cutter	
Needle-nosed pliers	



A soldering iron (a good one 25/30W, brand JBC for example)	
A magnifier on a double hand holder	
A sponge with a soldering iron stand	

2.2 Soldering the components

Before you get started here are some recommendations. Check the kit content and insure that you have indentified correctly all the components. Be careful to put the parts in the proper place, as it can be difficult to remove them. Read the reference on the component with the help of the magnifier glass.

Do not revert component such as the capacitor and whenever there is a « + » sign on a component (ie; it has to be plugged one way and not the other) then it is mentioned

Always start by the thinner components so that after you plugged them you do not have to hold them while soldering.

Some advices to do good soldering

- Do not hesitate to clean up frequently your soldering iron in order to do good soldering.
- Always start by the thinner components and then plug them to the board.
- Heat the board and component lead together first and then bring the solder when hot enough.

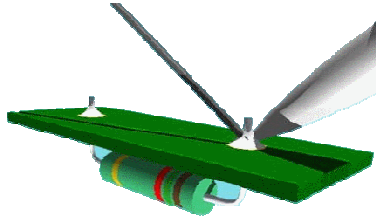

- Do not overheat the components as it could permanently damage them. Be careful to solder properly if you want them to last, something working today might not later. Just one missing connection can cause failure.

- Always work in a comfortable position on a tidy table with some space.

If you need help to solder your components just check on the internet there is lots of good tutorial out there that will teach you how to do some soldering.

3 What is an AVR programmer?

The AVR programmer is an interface between your USB port and the adapter. To use your adapter, you need to get an AVR programmer like the one below.





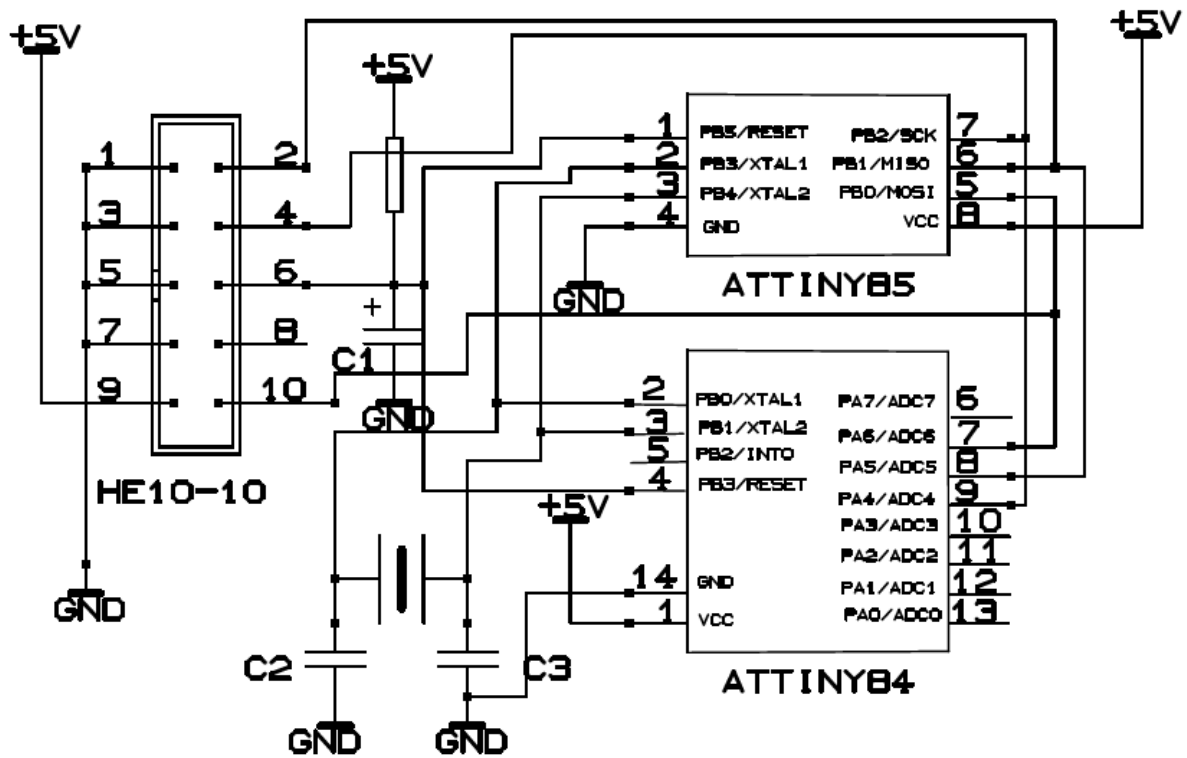

4 Adapter board

The adapter looks like the schema below





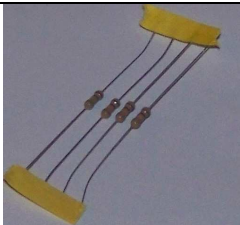
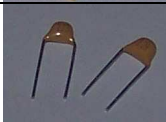

5 Building your adapter

The components list is as follow

R1	10Kohm (brown, black and orange)	
C1, C2	22pf	
C3	47µf (- is marked on the cap, + is the other lead)	

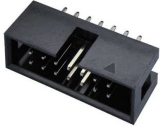

Q1	16Mhz Cristal	
IC1	14 pins ZIF socket	
IC2	8 pins socket	
J1, J2	Jumpers (used to enable or not the crystal)	
connector	4 pins strip that you need to cut to 2 x 2 pins strip	
	Box header 10 connector	

You can then quickly build it and use a ZIF socket. This is pretty strait forward make sure that you solder the components on the side where they are drawn. Make also sure that the box header connector is soldered in the correct position otherwise you could damage your AVR programmer and/or adaptor. Check also the 47µF capacitor.

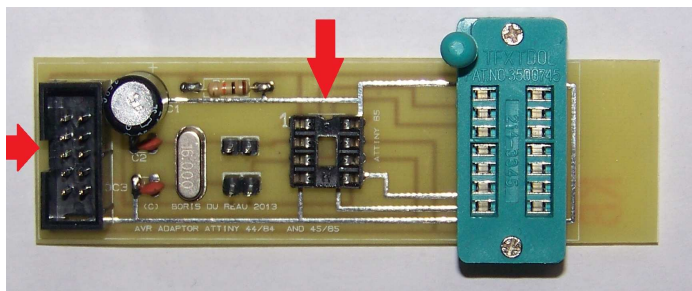

6 Use your AVR adapter

6.1 The jumpers

The 2 jumpers next to the crystal will enable or disable it. Typical usage of the adaptor is with all the jumpers removed so that the internal oscillator is used.



6.2 Programming a chip

The following instructions are for people using it with the Arduino environment.

6.2.1 Burning a bootloader

On the Mini Alt Duo or Alt Uno use an ATtiny 84 or 85. On the Arduino framework choose one of the attiny ship

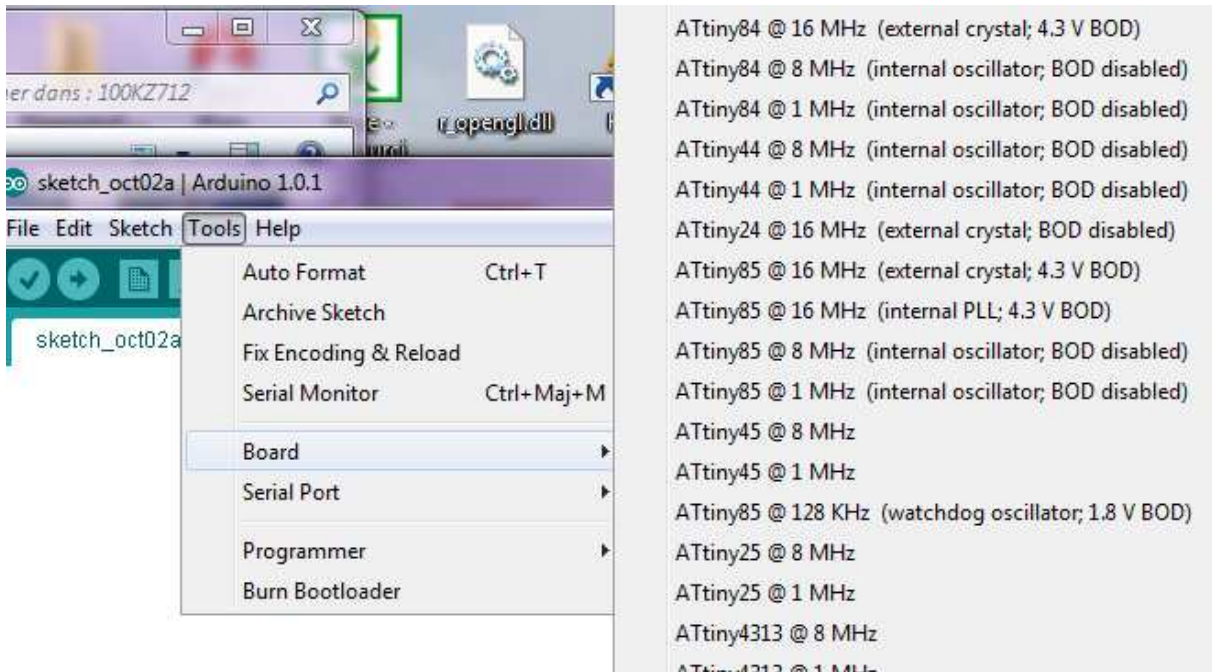

and then select your AVR programmer

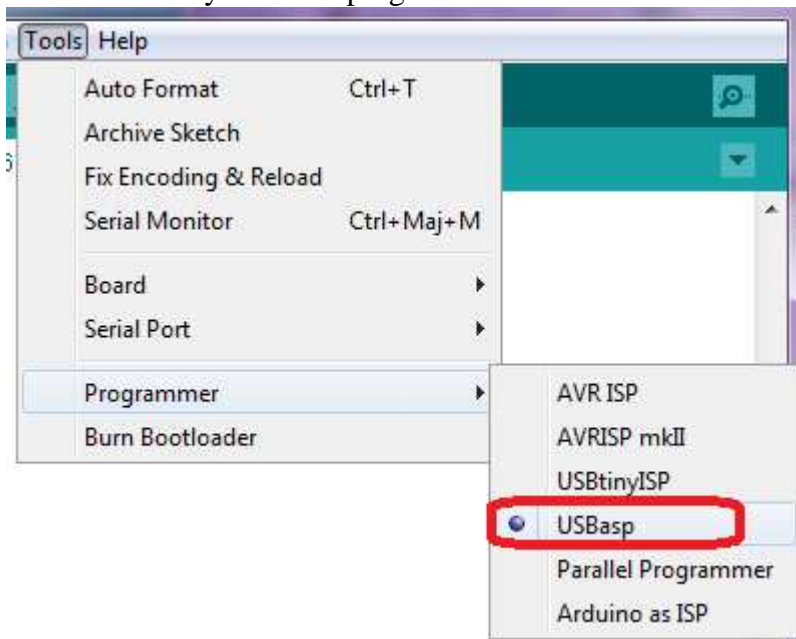

Then click on
Burn boot loader

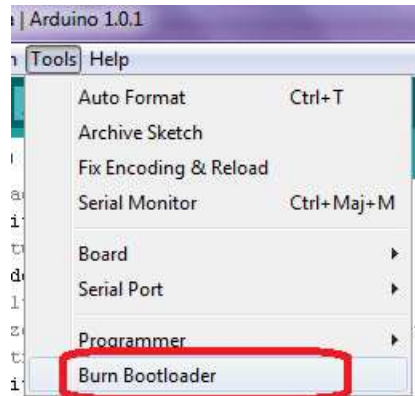

This will upload the Arduino Uno boot loader to your ATtiny 85 or 84

Make sure it says successful. If not you will need to try again. Sometime it does not work; and in this case you will have to use a special programmer to reset your chip.

6.2.2 Uploading a program

First you need to make sure that you have an Arduino bootloader.

Connect the AVR programmer to your PC exactly the same way that you did for burning the boot loader.

On the Arduino framework when you upload the program choose the option

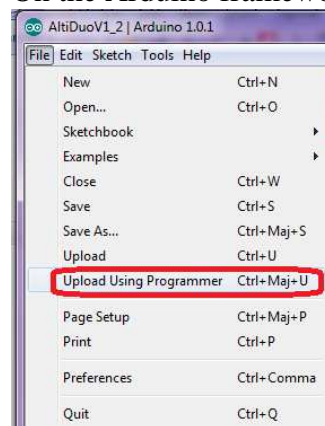



```
AltDuoV1_2 | Arduino 1.0.1
File Edit Sketch Tools Help
AltDuoV1_2 $
// This will be the ASL altitude during the flight, and the AGL al
float KalmanCalc (float altitude)
{
  //Predict kalman_x_temp, kalman_p_temp
  kalman_x_temp = kalman_x_last;
  kalman_p_temp = kalman_p_last + kalman_r;

  //Update kalman values
  kalman_k = (f_l/(kalman_p_temp + kalman_q)) * kalman_p_temp;
  kalman_x = kalman_x_temp + (kalman_k * (altitude - kalman_x_tem
  kalman_p = (f_l - kalman_k) * kalman_p temp;
}

Done uploading.
tiDuoV1_2.cpp.hex contains 11994 bytes
avrdude: reading on-chip flash data:

Reading | ##### |
100% 3.48s

avrdude: verifying ...
avrdude: 11994 bytes of flash verified

avrdude done. Thank you.

155 Arduino Uno on COM13
```